

PERFORMANCE
MADE
SMARTER

Product manual

2281

Ramp generator



EAC

UK
CA

CE

TEMPERATURE | I.S. INTERFACES | COMMUNICATION INTERFACES | MULTIFUNCTIONAL | ISOLATION | DISPLAY

No. 2281V103-UK
From serial no.: 211385001

PR
electronics

6 Product Pillars

to meet your every need

Individually outstanding, unrivalled in combination

With our innovative, patented technologies, we make signal conditioning smarter and simpler. Our portfolio is composed of six product areas, where we offer a wide range of analog and digital devices covering over a thousand applications in industrial and factory automation. All our products comply with or surpass the highest industry standards, ensuring reliability in even the harshest of environments and have a 5-year warranty for greater peace of mind.

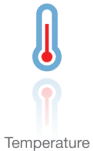

Our range of temperature transmitters and sensors provides the highest level of signal integrity from the measurement point to your control system. You can convert industrial process temperature signals to analog, bus or digital communications using a highly reliable point-to-point solution with a fast response time, automatic self-calibration, sensor error detection, low drift, and top EMC performance in any environment.



We deliver the safest signals by validating our products against the toughest safety standards. Through our commitment to innovation, we have made pioneering achievements in developing I.S. interfaces with SIL 2 Full Assessment that are both efficient and cost-effective. Our comprehensive range of analog and digital intrinsically safe isolation barriers offers multifunctional inputs and outputs, making PR an easy-to-implement site standard. Our backplanes further simplify large installations and provide seamless integration to standard DCS systems.



We provide inexpensive, easy-to-use, future-ready communication interfaces that can access your PR installed base of products. All the interfaces are detachable, have a built-in display for readout of process values and diagnostics, and can be configured via push-buttons. Product specific functionality includes communication via Modbus and Bluetooth and remote access using our PR Process Supervisor (PPS) application, available for iOS and Android.



Our unique range of single devices covering multiple applications is easily deployable as your site standard. Having one variant that applies to a broad range of applications can reduce your installation time and training, and greatly simplify spare parts management at your facilities. Our devices are designed for long-term signal accuracy, low power consumption, immunity to electrical noise and simple programming.



Our compact, fast, high-quality 6 mm isolators are based on microprocessor technology to provide exceptional performance and EMC-immunity for dedicated applications at a very low total cost of ownership. They can be stacked both vertically and horizontally with no air gap separation between units required.



Our display range is characterized by its flexibility and stability. The devices meet nearly every demand for display readout of process signals and have universal input and power supply capabilities. They provide a real-time measurement of your process value no matter the industry and are engineered to provide a user-friendly and reliable relay of information, even in demanding environments.

Ramp generator 2281

Contents

Applications	2
Technical characteristics	2
Inputs	2
Functions	2
Ramp generator with internal time measurement	2
Ramp generator with external pulses	2
Ramp generator for 2-phase encoder	3
Output	3
Order	4
Electrical specifications	4
Block diagram	5
Hardware programming	6
Routing diagram	7
Configuration / operating the function keys	8
Description of functions (selection of application)	10
Document history	12

Ramp generator 2281

- Multiple functions
- Programmable from front
- 3-digit LED display
- NPN and PNP inputs
- Internal ramp time or external pulses
- Reset or preset function

Applications

To convert digital signals to a time-controlled analogue signal with either internally entered up/down time or with external pulses for up/down function. Can convert digital outputs to analogue outputs. By connection of a 2-phase encoder as up/down pulse generator the pulses will be converted to an analogue position signal. Especially suitable in applications where easy 11-pole relay socket mounting is required for instance in a panel. Possibility of readout of the analogue value of the output through the built-in display.

Technical characteristics

General

The 2281 is microprocessor-controlled and basic-calibrated. This means that the input and output can be programmed acc. to the requested signal range without any readjustment. Thereby a high degree of accuracy and flexibility are ensured. The user interface consists of a 3-digit display and 3 function keys in the front. The interface is used to change a function, ramp time or an output signal range.

Inputs

6 digital inputs make it possible to choose reset, up/down functions as either NPN inputs (short circuit to gnd.) or as PNP input (+ 24 VDC). The trigger level is typically 8 VDC with a pull up/down resistance of 3.5 k Ω corresponding to a load current of 6.9 mA. Via an analogue switch the up and down inputs can be switched between input filters for a pulse length > 10 ms or > 0.5 ms. The chosen filter is the same for all up/down inputs. The 10 ms filter is used for elimination of contact-bounce. The reset inputs have a filter for pulse lengths > 30 ms. The arrow keys can be selected to work in parallel with the digital up and down inputs.

Functions

Ramp generator with internal time measurement

Up ramp and down ramp can be set separately in the time span 0.1...999999 s. Reset can be chosen to preset at any value between 0 and 100% output signal. The up/down time measurement starts when the time constant of the selected filter has been exceeded.

If the up/down inputs are activated simultaneously, both ramps will be activated and the outputs rise/fall with the difference of the times.

Ramp generator with external pulses

Up ramp and down ramp can be adjusted separately with a number of pulses between 1 and 15,615,744. The entered number of pulses (max. 60999) are multiplied by the prescaler which can assume values between 1 and 256. Reset can be chosen to preset at any value between 0% and 100% output signal. The pulse length must be longer than the time constant of the selected filter. If the up/down inputs are activated simultaneously both input pulses will be scanned and the output will rise/fall with the difference of the pulses. In case of supply drop-out the position will be remembered when the prescaler is 1.

Ramp generator for 2-phase encoder

The ramp pulses are set to a value between 1 and 15,615,744. The entered number of pulses (max. 60999) is multiplied by the prescaler which can assume values between 1 and 256. The pulse length must be longer than the time constant of the selected filter.

When the encoder is turned in one direction the output rises compared to the set number and pulses, when the encoder is turned in the opposite direction the output falls proportionally.

The reset can be chosen to preset at any value between 0% and 100% output signal. By activating reset for instance in a 50% position an auto-calibration of the measuring system is obtained. In case of supply drop-out the position will be remembered when the prescaler is 1.

Output

Analogue standard current output of 0/4...20 mA or, with JP3 off, 0/2...10 mA. The output span can be set to any value within the standard ranges with a max. offset of 50% of the max. value and a minimum span of 5 mA. Restart after a supply drop-out can be chosen to generate either the reset value or the value which the output had just before the supply drop-out.

Maximum load is 600 Ω / 12 VDC. By short-circuit of pins 3 and 2 the output current is converted to a standard voltage of 0/0.2...1 VDC, 0/2...10 VDC or special VDC dependent on the size of R65. The voltage signal is available between pins 2 and 1.

See hardware programming for correct choice.

An overrange can be defined thereby enabling the output to exceed the selected signal range by $\pm 3\%$ within the limit of 0...20.5 mA.

Order

Type
2281

Electrical specifications

Environmental conditions

Operating temperature	-20°C to +60°C
Calibration temperature	20...28°C
Humidity	< 95% RH (non-cond.)
Protection degree	IP50

Mechanical specifications

Dimensions (HxWxD)	80.5 x 35.5 x 84.5 mm (D is without pins)
Weight approx.	120 g

Common specifications

Supply voltage	19.2...28.8 VDC
Internal consumption	2.4 W
Max. consumption	2.7 W
Programming	Front-programmable
Response time	< 60 ms
Signal / noise ratio	Min. 60 dB
Up ramp time	0.1...999999 s
Down ramp time	0.1...999999 s
External pulses	1...15,615,744
Signal dynamics, output	16 bit
Effect of supply voltage change	< ±0.005% of span/%V
Temperature coefficient	< ±0.01% of span/°C
Linearity error	< ±0.1% of span
EMC immunity influence	< ±0.5%

Electrical specifications - INPUT

Digital input

Up / down inputs

NPN	Pull up 24 VDC / 6.9 mA
PNP	Pull down 0 VDC / 6.9 mA
Pulse width, programmable	>10 ms / > 0.5 ms
Input frequency (max.)	50 Hz / 1 kHz

Reset inputs

NPN	Pull up 24 VDC / 6.9 mA
PNP	Pull down 0 VDC / 6.9 mA
Pulse width	> 30 ms
Input frequency (max.)	16 Hz

Electrical specifications - output

Current output:

Signal range	0...20 mA
Min. signal range (span)	5 mA
Max. offset	50% of selected max. value
Load (max.)	20 mA / 600 Ω / 12 VDC
Load stability	< ±0.01% of span/100 Ω
Current limit	20.5 mA

Of span = Of the presently selected range

Voltage input via an internal shunt

Signal range.	0...10 VDC
Min. signal range (span).	250 mV
Max. offset	50% of selected max. value
Load (min.)	500 kΩ
Voltage limit	10.25 VDC

Observed authority requirements

EMC.	2014/30/EU & UK SI 2016/1091
RoHS.	2011/65/EU & UK SI 2012/3032
EAC.	TR-CU 020/2011

Block diagram

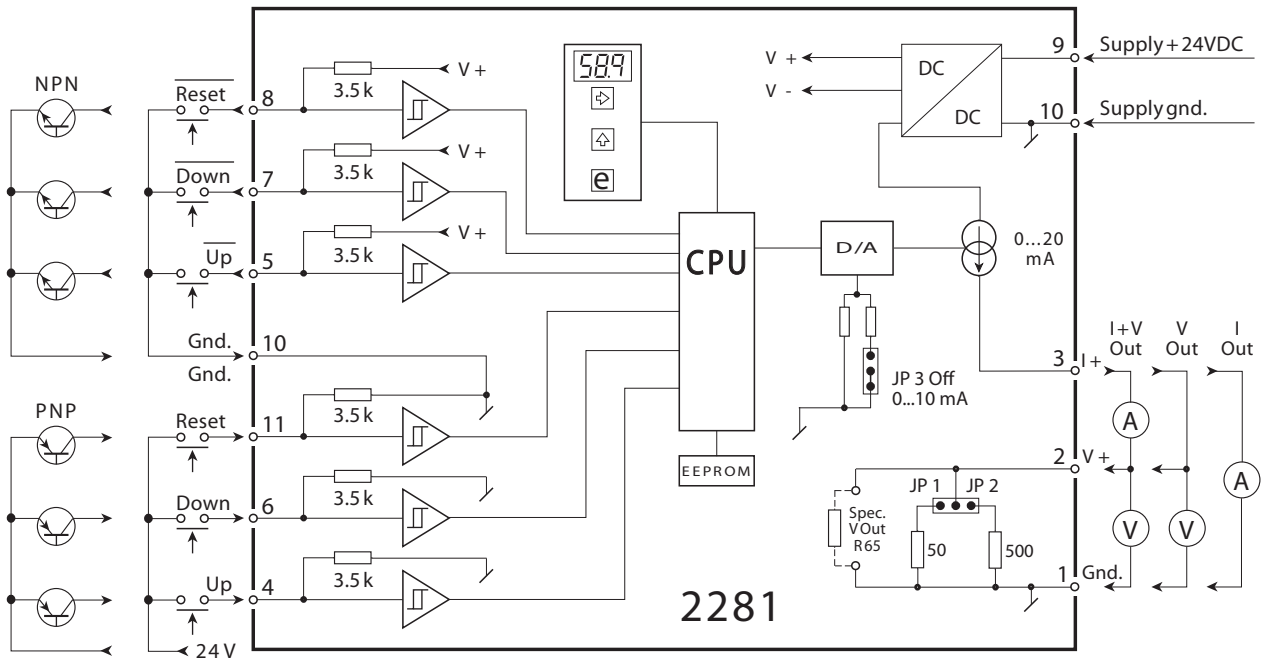

Hardware programming

JP1	JP2	JP3	Output	Menu 4.3
OFF	OFF	OFF ON	0...10 mA 0...20 mA	1 2
ON	OFF	OFF ON	0...500 mV 0...1000 mV	3 4
OFF	ON	OFF ON	0...5 V 0...10 V	5 6

Routing diagram

If no buttons are pressed for a period of 2 minutes, display returns to stage 0.0

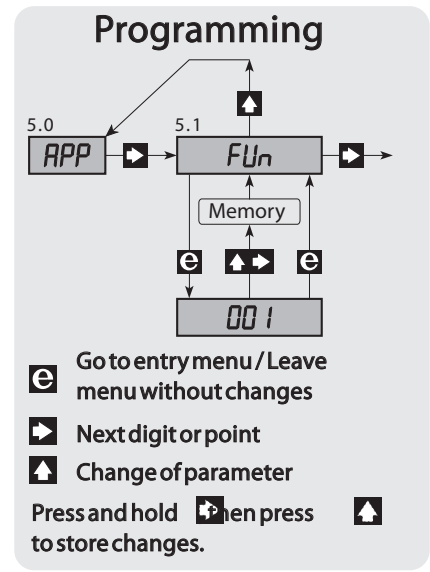
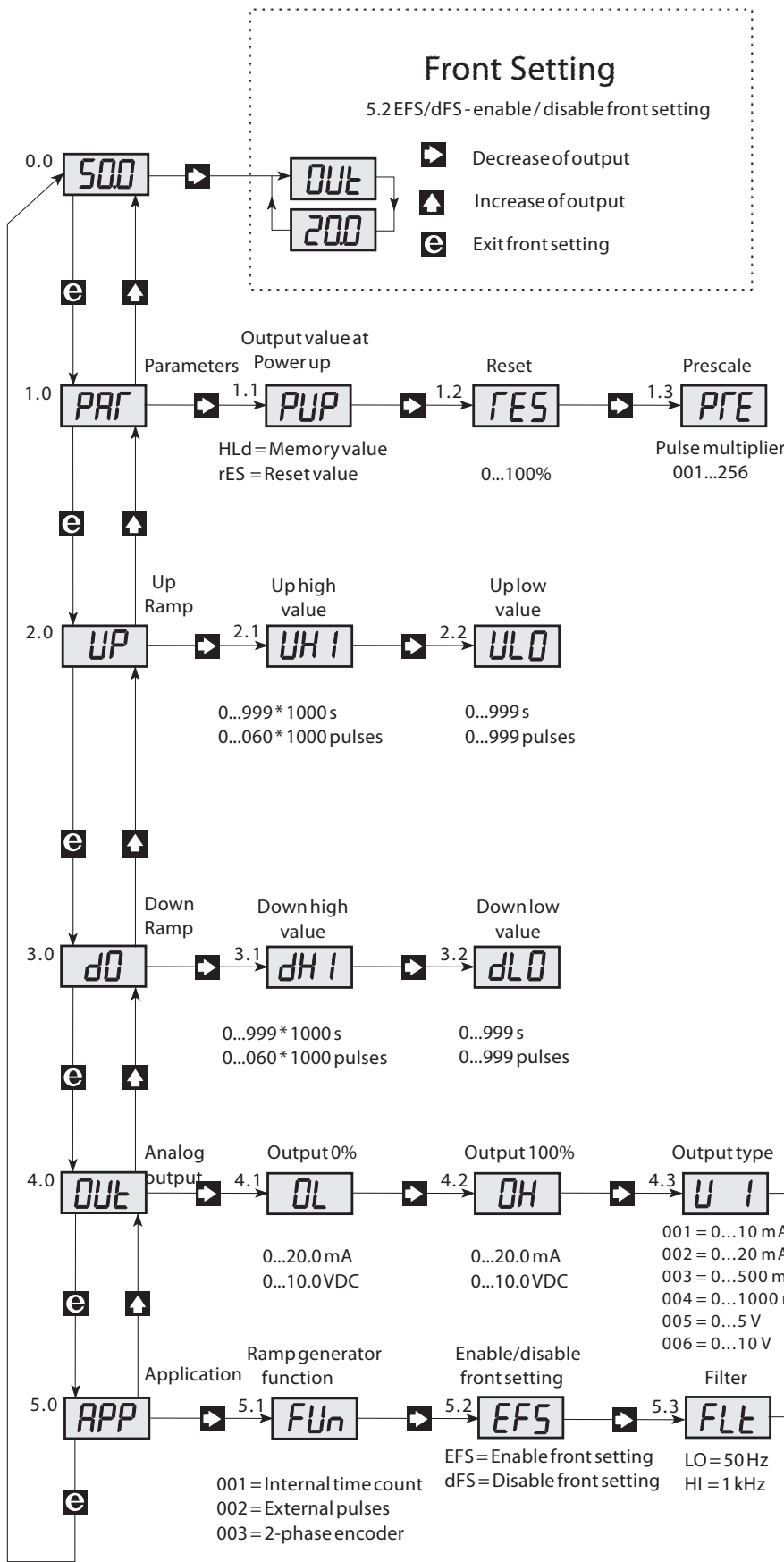





Configuration / operating the function keys



Documentation for routing diagram

General

The programming is menu-controlled. The main menus are numbered in level 0 (x.0), and the submenus are numbered in level 1 (x.1 to x.5). Each submenu has an accompanying entry menu. The menus are structured in such a way that the menus most frequently used are closer to the default menu 0.0. Please note that programming is only possible when submenu 5.4 PAS has the value 040.

Menus and submenus are selected by the 3 function keys , , and  as outlined in the routing diagram.

Activating  will display the current value. In entry menus, the digit that can be changed will flash.

Active digit position is shifted by the  key, and the value is changed by the  key. When the decimal point flashes, its position can be changed by the  key.

In parameter selection menus you switch between the parameters by the  key.

Store by first activating  and then  simultaneously.



To return to the previous menu without changing the parameters - activate .

If a non-valid value is entered, the display will show Err for 2 s and then return to the entry menu with the initial parameters.

0.0 Default - The output value is displayed in %

The display returns to default at power ON, or if no keys have been activated for a period of 2 minutes.

Front Setting - Manual operation of up ramps or down ramps.

When menu 5.2 has been selected as EFS (Enable Front Setting), you can ramp up or down by way of the Front Setting function. In this menu the function keys have a special function, as  corresponds to the activation of the "UP" input, and  corresponds to the activation of the "DOWN" input. The output value is displayed in %.

Activate  to leave the Front Setting menu and to store the present ramp value.

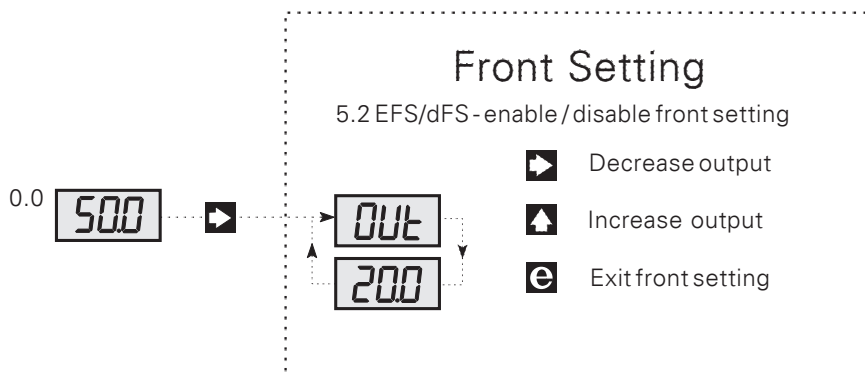
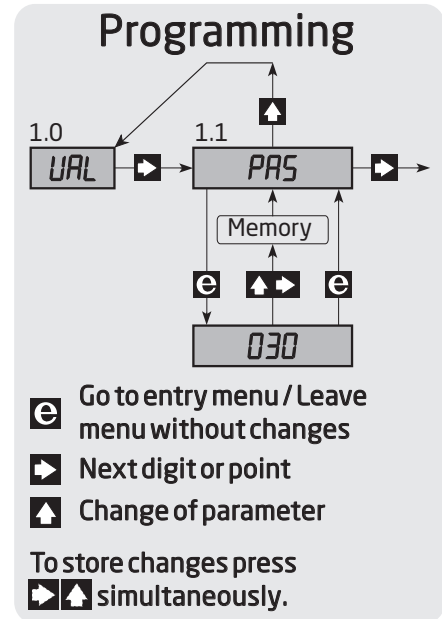

1.0 PAr - Parameter menu - selection of Power up / reset value and prescaler

1.1 PUP - Setting of output value at Power up

Selection of the function which the output will follow at Power up.

At HLd the output is set to the value it had immediately before power down. At rES the output is set to the present value of menu 1.2.

Possible selections are HLd - the memory value, and rES - the reset value.

1.2 rES - Setting of reset / preset value

The reset value is set in % of the output span.

Valid selections are 0...99.9%.

1.3 PrE - Setting of prescaler for external pulses

The prescaler is multiplied on the set up and down pulses. When the external pulse number is ≤ 60999 , the prescaler is set to 1.

Valid selections are 1...256.

2.0 UP - Setting of up ramps

When menu 5.1 = { 1 = Internal time measurement }, the up ramp is set in seconds and menu 1.3 (prescaler) has no function.

When menu 5.1 = { 2 = External pulses or 3 = 2-phase encoder }, the up ramp is set in number of pulses ≤ 60999 . The pre-scaler set in menu 1.3 is multiplied on the entered up pulses.

2.1 UHI - Setting of up ramps in thousands

Valid selections are 0...999 (* 1000 s) or 0...60 (* 1000 pulses).

2.2 UL0 - Setting of up ramps in ones

Valid selections are 0...999 s or pulses.

3.0 d0 - Setting of down ramps

When menu 5.1 = { 1 = Internal time measurement }, the down ramp is set in seconds and menu 1.3 (prescaler) has no function.

When menu 5.1 = { 2 = External pulses or 3 = 2-phase encoder }, the down ramp is set in number of pulses ≤ 60999 . The prescaler set in menu 1.3 is multiplied on the entered down pulses.

3.1 dHI - Setting of down ramps in thousands

Valid selections are 0...999 (* 1000 s), or 0...60 (* 1000 pulses).

3.2 dL0 - Setting of down ramps in ones

Valid selections are 0...999 s or pulses.

4.0 OUt - Setting of signal output

4.1 OL - Entry of 0% output signal

Possible selections are current 0.0...20.0 mA, or voltage 0.0...10.0 VDC.

4.2 OH - Entry of 100% output signal.

Possible selections are current 0.0...20.0 mA, or voltage 0.0...10.0 VDC.

4.3 UI - Selection of current or voltage output

The basic calibration data within the module varies according to the selected output signal range, which means that the current output is current-calibrated, and the voltage output is voltage-calibrated by way of the installed internal resistors.

See the hardware programming for correct jumper setting.

Possible selections are:

001 = current output in the range 0...10 mA

002 = current output in the range 0...20 mA

003 = voltage output in the range 0...500 mV

004 = voltage output in the range 0...1000 mV

005 = voltage output in the range 0...5 V

006 = voltage output in the range 0...10 V

4.4 OR Selection of Overrange

If ON has been selected, the output can exceed the selected output span by $\pm 3\%$. However, only within 0 to 20.5 mA. If OFF has been selected, the output is limited by the selected output span.

Possible selections are ON or OFF.

5.0 APP - Selection of application

5.1 FUn - Selection of function

Common to all functions is the selection of filter (FLt) in menu 5.2. Depending on the selection, the up/down pulse length must be > 10 ms (50 Hz), or > 0.5 ms (1 kHz).

The reset input has a fixed filter of 30 ms (16 Hz).

At power up the output value can be set to adopt the value it had immediately before power down, or set to adopt the same value as at reset. The reset value can be set to a value between 0 and 99.9% of the output span.

Possible selections of function are:

001 = Ramp generator with internal time measurement

The up and down ramps can be set separately in the time range 0.1...999999 s. The up/down time measurement starts when the inputs have been activated longer than the time constant of the connected filter.

If the up/down inputs are activated simultaneously, both ramp times will be measured and the output will decrease/increase by the difference between the times.

002 = Ramp generator with external pulses

The up and down ramps can be set separately by pulse numbers between 1 and 15,615,744 which are set in menu 2.0 UP/3.0 dO and menu 1.3 PrE respectively.

The values set in menu 2.0 and 3.0 (1...60999) are multiplied by the value set in menu 1.3 (1...256). An up ramp of 75258 pulses is set in menu 2.1 to 37; in menu 2.2 to 629; and in menu 1.3 to 2 ($37629 \times 2 = 75258$). With a pre-scaler of 2, the number of pulses on the down ramp must also be set as (number of pulses / 2). The up/down pulses are detected when the inputs are activated longer than the time constant of the connected filter. If the up/down inputs are activated simultaneously, both input pulses will be read, and the output will increase/decrease by the difference between the pulses.

003 = Ramp generator for 2-phase encoder

The resolution of the applied 2-phase encoder is doubled, as both the leading and trailing edges on the pulses are counted. A 2-phase encoder with 100 pulses per revolution which is to be revolved 10 times, must be set to 2000 pulses ($100 \times 10 \times 2$). The ramp pulses can be set with a pulse number between 1 and 15,615,744, which is set in menu 2.0 UP and 1.3 PrE respectively.

Menu 3.0 has no function at a 2-phase encoder. The value set in menu 2.0 (1...60999) is multiplied by the value set in menu 1.3 (1...256). If the encoder yields 30000 pulses for instance, the ramp pulses must be set to 60000 by setting menu 2.1 to 60, menu 2.2 to 000, and menu 1.3 to 1 ($60000 \times 1 = 60000$). The ramp pulses are detected when the inputs are activated longer than the time constant of the connected filter. When the encoder is turned in one direction, the output increases according to the set number of pulses. When the encoder is turned in the opposite direction, the output decreases accordingly.

The output signal represents the encoder position and can be autocalibrated by activating the reset input. If the reset input is activated at for instance the 50% position of the encoder, the reset value must be set at 50%. Please note that as long as the reset inputs are active (> 30 ms), the output will adopt the set reset value.

5.2 EFS - Enable/disable Front Setting

Access to change of ramp value is determined by the parameters EFS (Enable Front Setting) - change of ramp value is possible; or dFS (disable Front Setting) - locking of change of ramp value.

Possible selections are EFS or dFS.

5.3 FLt - Setting of up/down filter

The filter can be set to a pulse length of > 10 ms (50Hz), or > 0.5 ms (1kHz).

Possible selections are LO - 50Hz, or HI 1 kHz.

5.4 PAS - Password

When the password is 040, changes can be made in all menu points. When the password is <> 040, programming in all menu points is locked but open for reading of settings.

Possible selections are 0...999.

Document history

The following list provides notes concerning revisions of this document.

Rev. ID	Date	Notes
103	2232	UKCA added.

We are near you, *all over the world*

Our trusted red boxes are supported wherever you are

All our devices are backed by expert service and a 5-year warranty. With each product you purchase, you receive personal technical support and guidance, day-to-day delivery, repair without charge within the warranty period and easily accessible documentation.

We are headquartered in Denmark, and have offices and authorized partners the world over. We are a local business

with a global reach. This means that we are always nearby and know your local markets well.

We are committed to your satisfaction and provide PERFORMANCE MADE SMARTER all around the world.

For more information on our warranty program, or to meet with a sales representative in your region, visit prelectronics.com.

Benefit today from *PERFORMANCE MADE SMARTER*

PR electronics is the leading technology company specialized in making industrial process control safer, more reliable and more efficient. Since 1974, we have been dedicated to perfecting our core competence of innovating high precision technology with low power consumption. This dedication continues to set new standards for products communicating, monitoring and connecting our customers' process measurement points to their process control systems.

Our innovative, patented technologies are derived from our extensive R&D facilities and from having a great understanding of our customers' needs and processes. We are guided by principles of simplicity, focus, courage and excellence, enabling some of the world's greatest companies to achieve PERFORMANCE MADE SMARTER.